

# ILLUMINATI'S EXTRUSION

## APPLICATION

The Light Bar system is a custom fabrication using the ILLUMINATI's 34DA or ILLUMINATI's 34DB mini trumpet fitting. Each Light Bar is made to order. The fittings and optionally small interspersed points of light can be placed at regular or irregular intervals to suit what is being illuminated. Bars are available black or white as standard and in a range of powder coat colours to your specified RAL colour. The 34D eyeballs are always black while the trumpets can be black or painted to a custom colour. End caps are available if required. The normal active diameter of fibre used is 3mm (2mm can be used to good effect with metal halide light sources). Brackets can be supplied if required and the Clip Style bracket, which can be retrofitted, is ideal for horizontal mounting. Brackets can be pre-fitted.

The ILLUMINATI's 34D has two versions -  
 ILLUMINATI's 34DA with c. 20 - 30 degree focus  
 ILLUMINATI's 34DB with c. 55 - 60 degree focus

Light Bars using 2mm or 3mm fibre in fittings with optional 1.5mm or 1.8mm points for infill with a single 30mm common end and tails from one end

Profile	1.5mm*	1.8mm*	2mm	3mm
27mm	35	30	15	10
32mm	50	45	22	12
38mm	70	65	35	18
44mm	100	90	55	34

When using a mini common end connector, the maximum tails per bar is 10 of 3mm fibre or 26 of 2mm fibre. Where infill points \* are used, reduce the maximum number of fittings proportionally.

### Cutouts for feeding Light Bars through an aperture

Bar Size	A	X	Y	Z
27mm	41	29	8	9
32mm	48	34	8	9
38mm	52	40	8	9
44mm	61	46	8	9

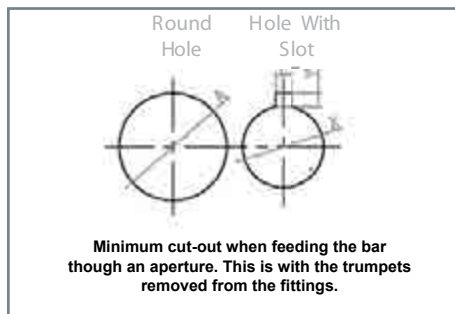

Specifier's Reference

Project

Type

Model No.

Comments or Special Instructions

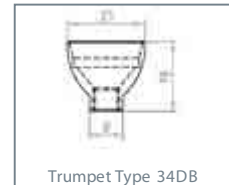
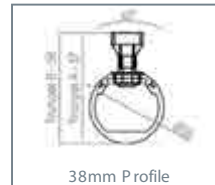
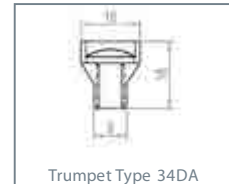

# ILLUMINATI'S BRACKETS

Specifier's Reference
Project
Type
Model No.
Comments or Special Instructions

## APPLICATION

A number of types of accessory brackets are available for Tubes and Bars. For LightWand brackets please see the LightWand section. The Round Brackets are for vertical or horizontal mounting of tubes. The tube is locked with a grub screw. They are also available round or with either one straight side or two straight sides to allow mounting as close as possible to a flat

surface or in a corner. Square Brackets are for surface mounting tubes horizontally or vertically and come as split halves. Adjustable Clip Brackets allow for horizontal mounting and the standoff can be extended using threaded rod. They can be fitted on site, even to Light Bars.

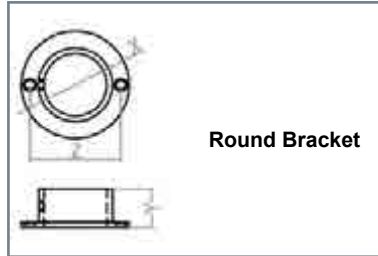

**Round Bracket**

Dimensions (mm)		Part No.	X	Y	Z
Tube Size					
27mm		ABR27R	50	20	41.5
32mm		ABR32R	55	20	46.5
38mm		ABR38R	62	20	53
44mm		ABR44R	67	20	58.5
52mm		ABR52R	75.5	20	67

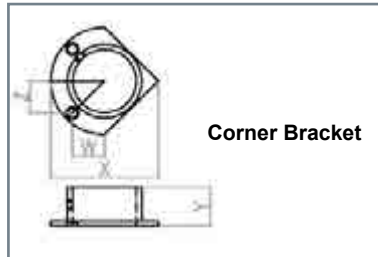

**Corner Bracket**

Dimensions (mm)		Part No.	W	X	Y	Z
Tube Size						
27mm		ABR27C	10.25	50	20	14.5
32mm		ABR32C	16.5	55	20	16.5
38mm		ABR38C	19.5	62	20	18
44mm		ABR44C	20.5	67	20	20.5
52mm		ABR52C	25.25	84.5	20	25.25

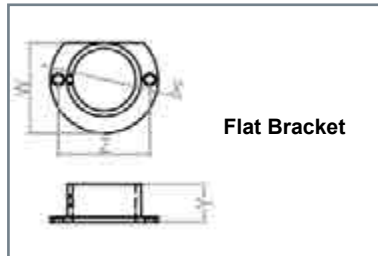

**Flat Bracket**

Dimensions (mm)		Part No.	W	X	Y	Z
Tube Size						
27mm		ABR27F	41.5	50	20	41.5
32mm		ABR32F	46.5	55	20	46.5
38mm		ABR38F	53	62	20	53
44mm		ABR44F	58.5	67	20	58.5
52mm		ABR52F	67	75.5	20	67

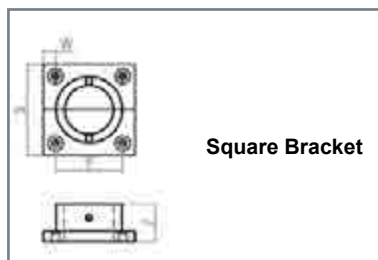

**Square Bracket**

Dimensions (mm)		Part No.	W	X	Y	Z
Tube Size						
32mm		ABR32S	8	60	44	25
38mm		ABR38S	8	66	50	25

N.B. Only available for 32mm and 38mm tube.

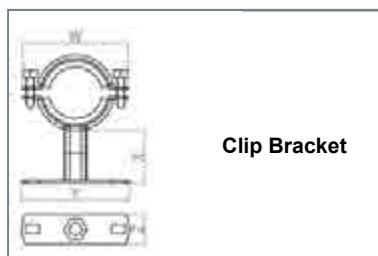

**Clip Bracket**

Dimensions (mm)		Part No.	W	X	Y	Z
Tube Size						
27/32mm		ABR32N	81.5	34	70	19.5
38/44mm		ABR40N	92	34	70	19.5
52mm		ABR48N	100	34	70	19.5

N.B. Has a black neoprene lining to help prevent scratching.

