

DMX EP-TOUCH-1 CONTROLLER



Product Introduction:

The EP-TOUCH-1 is a complete stand alone wall-mounted DMX controller is the perfect answer to interior lighting control expectations. Along with a state of the art design, the product comes with amazing features such as 1024 DMX channels, touch sensitive panel, clock/calendar, remote control, Ethernet facilities, and much much more....

Performance Parameter

Package	Interface, sdcard, datasheet, cdrom, usb cable
Software	ESA + ESA PRO on PC/Windows, ESA2 on PC + MAC
Application	ARCOLIS + EP-TOUCH REMOTE on iPhone/iPad/Android
Available colors	Frame (black or white), use the Stick Design Configurator web site
Options	Dedicated remote control (*), Power supply (*)
Standards	EC, EMC, ROHS, ETL, UL (some are in process)
Image size	Standard 150x110mm picture, contact us for a sample profile
Temperature	-10°C to 50°C
Dimensions	168x128x11,5 mm Complete package 250x150x55 mm
Weight	0,2 kg 0.44 lbs Complete package 0,6 kg 1.32 lbs

Specification

SPECIFICATIONS / CONNECTIONS		Built-in features	screw-terminal rear connector (9 pins)	extension socket rear connectors (2x10 pins)	front access connections (open cover)
Power Supply	9V DC 0.65A, supplied*				USB
DMX Output #1F	first universe, 512 channels DMX512 output		••		
DMX Output #2S	second universe, 512 channels DMX512 output (*)			•	
USB	USB 2.0 communication for PC/software				•
Ethernet	Advanced networking features	•			
Ports 1,2,3,4	Contact closure inputs, connect to ground for operating		••		
Ports 5,6,7,8	Contact closure inputs, connect to ground for operating			•	
User interface	14 buttons, 1 fader, 28 leds (Touch-sensitive keypad)*				power/data leds
SDCARD	Micro sd card for stand alone memory use (supplied)				•
RESET	Push button for reset operation				•
RS232	RS232 Serial communication for external synchronisation			•	
Output relay	Automatic Stand by 5V signal			•	
Clock	Real time clock and calendar, 10 minutes saving without power	•			
Infrared receiver	Easy learning triggering from any 36Khz remote control*				



Dimensions

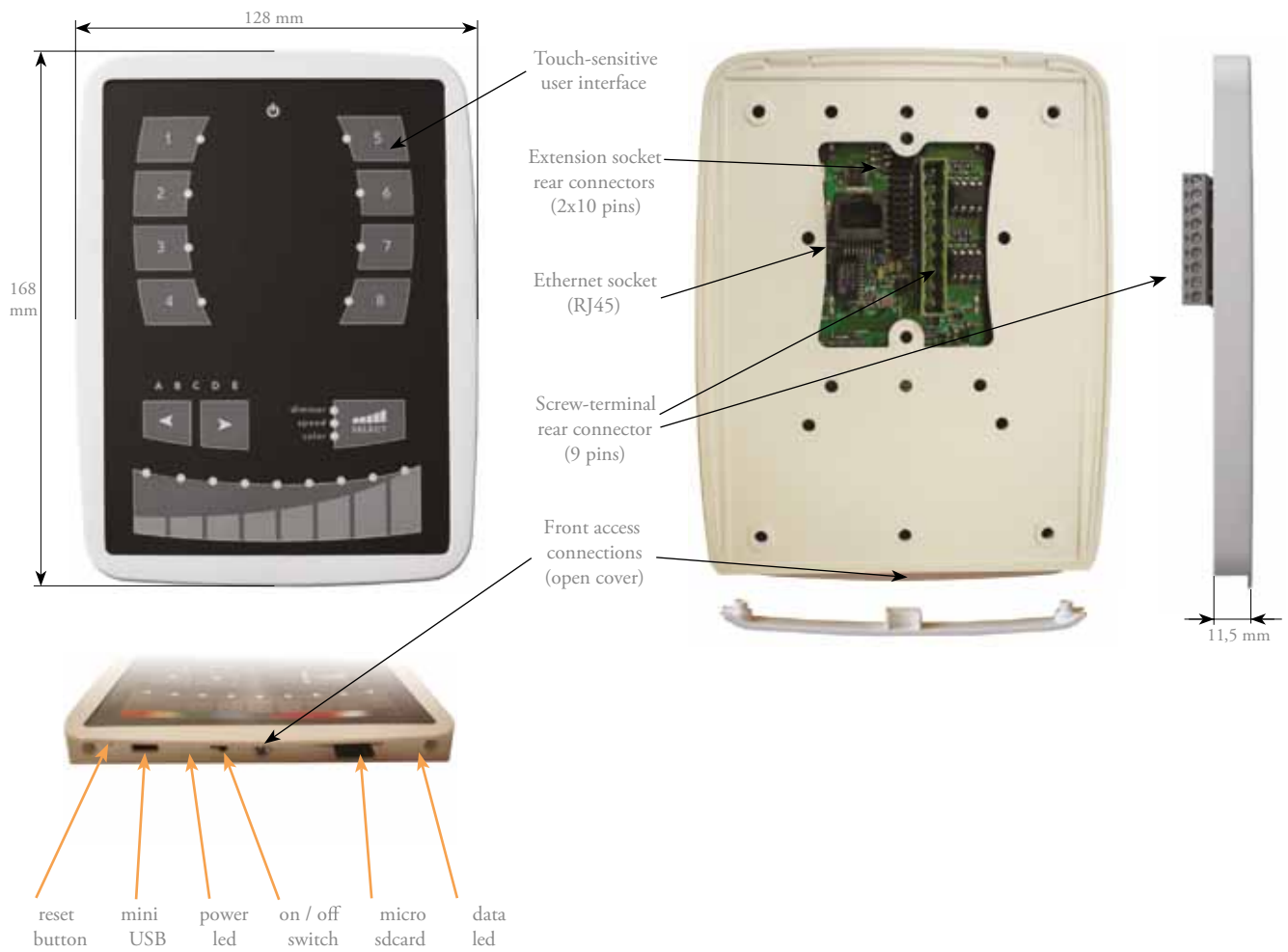

DMX EP-TOUCH-1 CONTROLLER

Installation

1. Mount an electrical box inside the wall

The EP-TOUCH-1 controller can be installed in any standard electrical backbox. If you use a double size box, you can insert the power supply inside.

2. Connect the wires

DMX: Connect the DMX cable to the lighting receivers (Leds, Dimmers, Fixtures..) (for XLR: 1=ground 2=dmx- 3=dmx+)

POWER: Connect a 9V DC 0.65A. Be sure to not invert the + and the ground.

3. Mount the interface on the wall

First, mount the back side of the interface on the wall with 2 or more screws

Secondly, plug the 2 connectors (see blue arrow)

Then, close the interface, using one screw

PORT 1,2,3,4 : If your application need to have some external contact closures, make the contacts between the ground and the ports

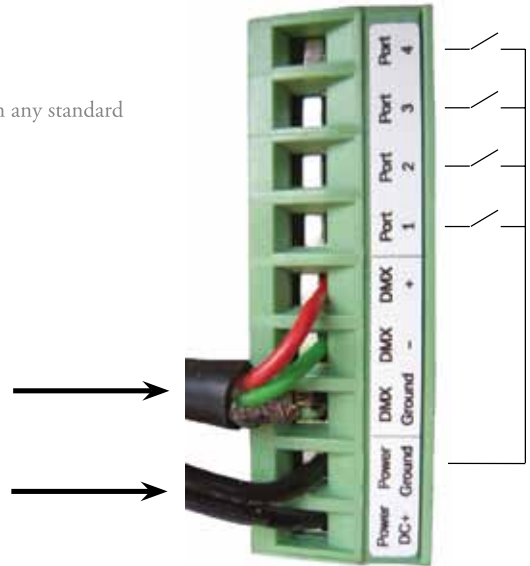

2x10 pins EXTENSION connector

P3		
RS232 TX	1	GND_DMX
RS232 RX	2	DMX1-
PORT7	3	DMX1+
PORT6	4	DMX2-
PORT5	5	DMX2+
PORT4	6	Relay
PORT3	7	3.3V
PORT2	8	IR_RX
PORT1	9	GND
PORT0	10	VIN

Compatible connectors:
 WURTH ELEKTRONIK ref: 61301021121
 MOLEX ref: 10-89-7202
 TE Connectivity ref: 1-87227-0
 FCI ref: 77313-101-20LF
 HARWIN ref: M20-9981046
 SAMTEC ref: TSW-110-xx-T-D
 FARNELL ref: 1841232
 RS ref: 763-6754 673-7534 251-8165
 MOUSER ref: 538-10-89-7202
 DIGIKEY ref: WM26820-ND

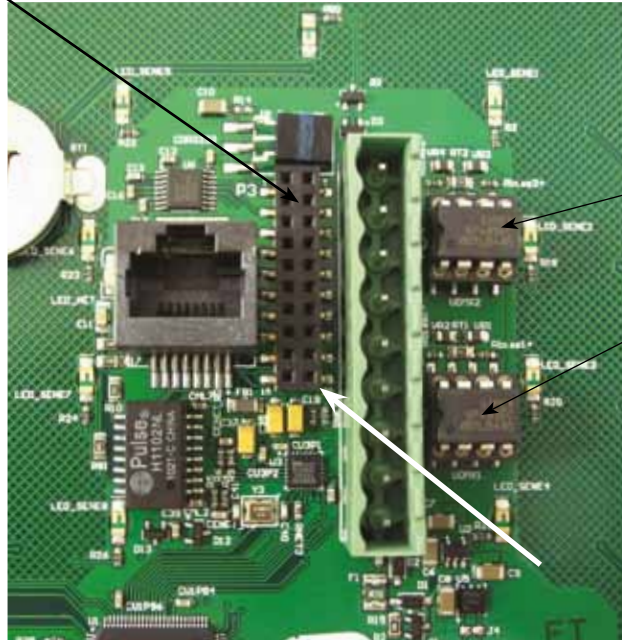

You can easily replace DMX CHIPS

DMX universe #2

DMX universe #1

Ref:
 SP485ECP-L
 MAX485CPA+

PORTS 1 to 8 make contacts between G (GND) and P1..P8

BLACKOUT relay (energy save) using the 2 pins : BK and G (GND)

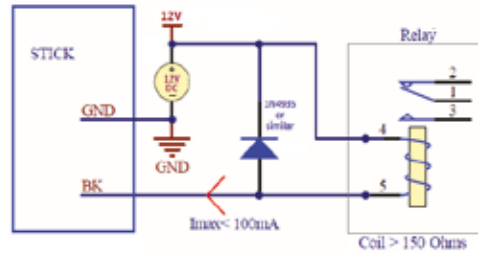

Example of relay : FINDER
 Ref. 22.23.9.012.4000
<http://www.findernet.com/fr/products/profiles.php?serie=22&lang=en>

RS232 triggering

Make a cable using the 3 pins : TX, RX and G (GND)

Set the RS232 parameters to : 9600bds 8 bits, no Parity, 2 Stop bits

- To play a scene, send 3 bytes : 1 x 255 (x = scene number)
- To stop a scene, send 3 bytes : 2 x 255 (x = scene number)
- To pause a scene, send 3 bytes : 3 x 255 (x = scene number)
- To release a pause, send 3 bytes : 4 x 255 (x = scene number)
- To reset a scene, send 3 bytes : 5 x 255 (x = scene number)

Note: the scene number (x) can be from 1 to 40. For instance, 11 means Page B Scene #3

SOFTWARE

ARCOLIS software (iPhone/iPad)
 ARCOLIS software (Android)

ESA, ESAPRO software (Windows)
 ESA2 software (Windows, Mac)
 ESA, ESAPRO manuals

EP-TOUCH REMOTE
 Remote application for iPhone/iPad, Android, Windows

Driver, Firmware, Tools

DMX EP-TOUCH-1 CONTROLLER



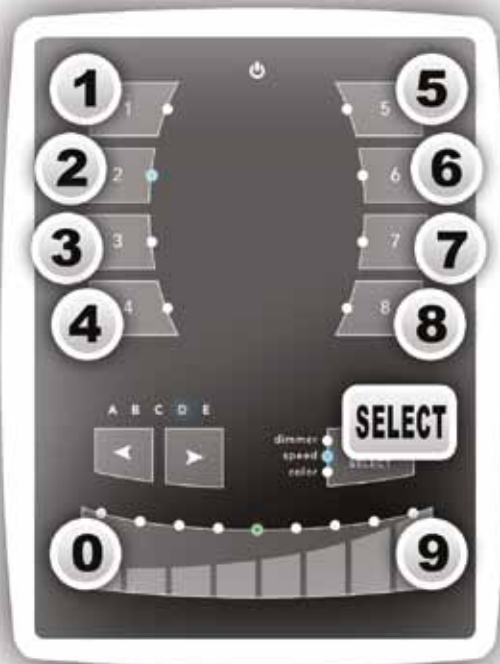









Some functions are available directly from the STICK keypad using the SELECT button.



WARNING

 = 3:30pm
3:30pm = 15:30
15:30 = **1530**

 = 5 DEC 2008
5 DEC 2008 = **051208**

	View time	Example : view 2:45pm = 14:45 = 1445 1445 = 2:45pm (USA) or 14:45 (Europe)
	View date	Example : view 6 SEP. 2009 date = 060909 060909 = September 6th 2009
	Set time	Example : set 3:30pm = 15:30 = 1530  = 1530
	Set date	Example : set 5 DEC 2008 date = 051230  = 051208
	Set Fade time	Example : set 01'32" fade time = 1 minute and 32 seconds = 0132  = 0132
	Lock function	 This function locks the keypad (disabled by default) Use the TOOLS program to enable it and set the 4-digit code
	Set IR	Example : assign an IR key to Scene #2 
	Firmware version	Example : view 1.02 firmware version = 0102 0102 = firmware version 1.02

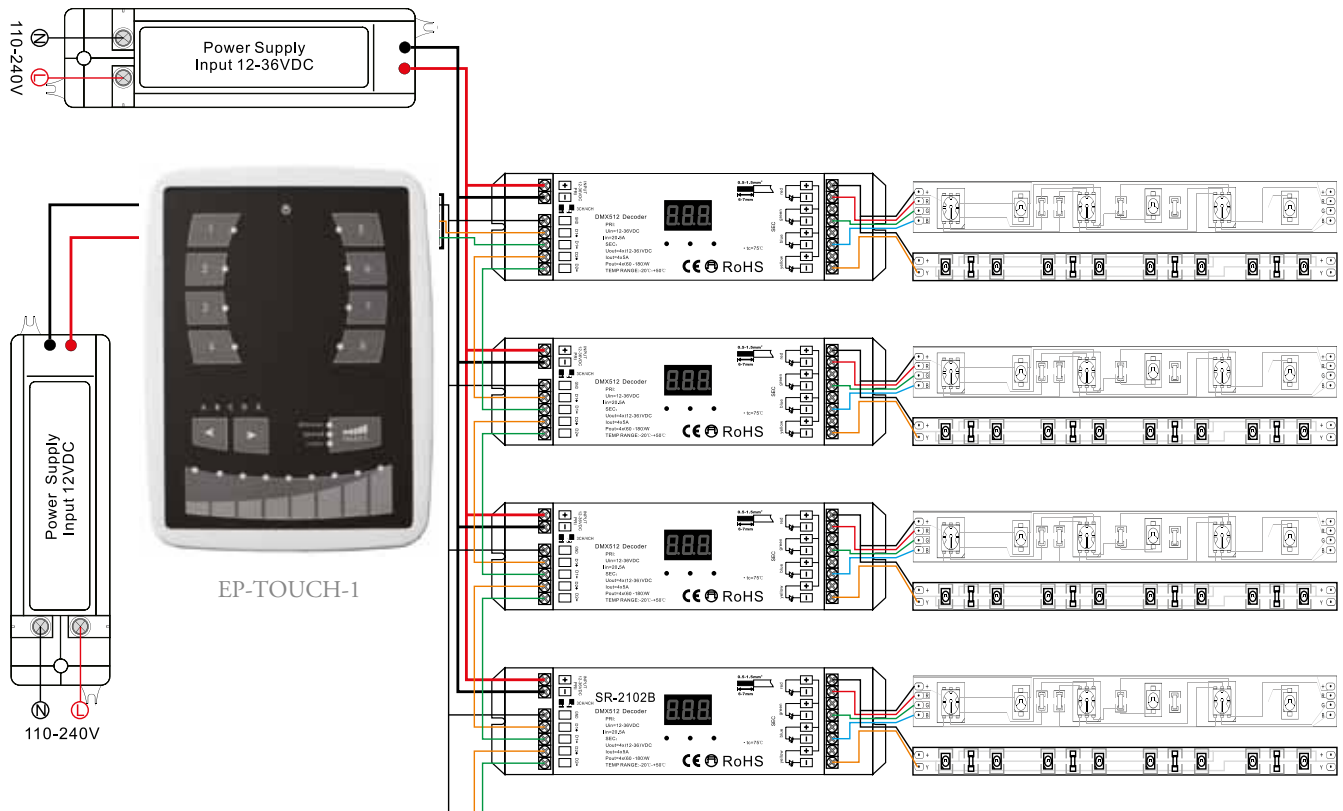

NETWORK SYNCHRONIZATION

